

This manual applies to photovoltaic modules (“PV modules”, also commonly known as solar panels) manufactured by Yingli Green Energy Holding Co. Ltd. (“Yingli Solar”), and is explicitly written for qualified professionals (“Installer” or “Installers”), including without limitation licensed electricians and RAL Certified PV Installers.

## INTRODUCTION

Thank you for choosing Yingli Solar as your PV module provider. We appreciate your business! This manual contains important information pertaining to the electrical and mechanical installation and maintenance of PV modules, and contains safety information that you must read carefully and be familiar with before handling, installing, and/or maintaining Yingli Solar PV modules.

Yingli Solar does not assume responsibility and expressly disclaims liability for losses, damages, or expenses arising out of, or in any way connected with this Installation and User Manual. Yingli Solar assumes no responsibility for any infringement of patents or other rights of third parties, which may result from using Yingli Solar PV modules. No license is granted expressly or by implication or under any patent or patent rights. The information in this manual is believed to be reliable, but does not constitute an expressed or implied warranty. Yingli Solar reserves the right to make changes to its PV modules and other products, their specifications, or this manual without prior notice.

Yingli Solar and its subsidiaries are not liable for any damages caused by inappropriate installation, use, or maintenance of Yingli Solar PV modules, including without limitation damages, losses, and expenses caused by non-observance of the instructions of this manual or caused by or in connection with products of other manufacturers.

Yingli Solar PV modules are designed to meet the requirements for the standards IEC 61215 and IEC 61730, application class A. Modules rated for use in this application class may be used in systems operating at greater than 50 V DC or 240 W, where general contact access is anticipated. Modules qualified for safety through IEC 61730-1 and IEC 61730-2 and within this application class are considered to meet the requirements for safety class II. In the course of the PV module certification process, the compliance of this manual with the certification requirements has been verified by an independent certification laboratory.

This Installation and User Manual is available in different languages. In cases of discrepancy between versions, the English language version shall control.

Failure to comply with the requirements listed in this manual will invalidate the Limited Warranty for PV Modules as provided by Yingli Solar at the time of sale to the direct customer. Additional recommendations are provided to enhance safety practices and performance results. Please provide a copy of this manual to the PV system owner for their reference, and inform them of all relevant aspects of safety, operation, and maintenance.

## SAFETY

### General

You must understand and follow all applicable local, state, and federal regulations and standards for building construction, electrical design, fire, and safety, and must check with local authorities to determine applicable permitting requirements before attempting to install or maintain PV modules.

Rooftop PV systems should only be installed on dwellings that have been formally analyzed for structural integrity, and confirmed to be capable of handling the additional weighted load of PV system components, including PV modules, by a certified building specialist or engineer.



For your safety, do not attempt to work on a rooftop until safety precautions have been identified and taken, including without limitation fall protection measures, ladders or stairways, and personal protective equipment (PPE).

For your safety, do not install or handle PV modules under adverse conditions, including without limitation strong or gusty winds, and wet or frosted roof surfaces.

The flat-plate PV module construction consists of a laminated assembly of solar cells encapsulated within an insulating material with a rigid glass surface and an insulated substrate. The laminated assembly is supported by an aluminum frame that is also used for mounting the module. See Figure 1 for an illustration of the PV module components.

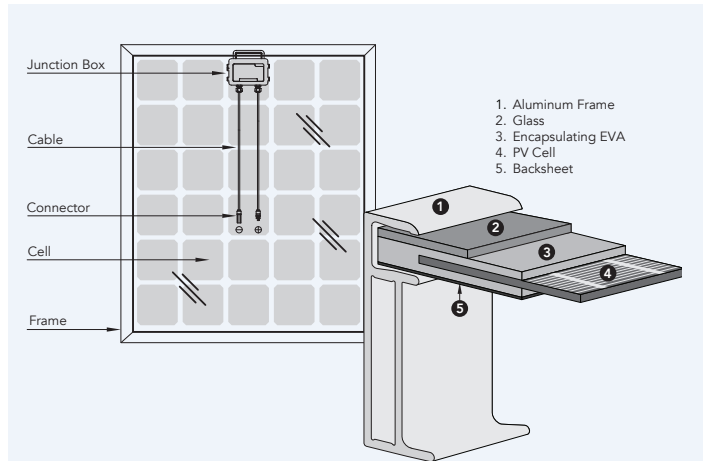

Figure 1: Module components and cross-section of the laminated assembly

### Electrical



PV modules can produce current and voltage when exposed to light of any intensity. Electrical current increases with higher light intensity. DC voltage of 30 Volts or higher is potentially lethal. Contacting the live circuitry of a PV system operating under light can result in lethal electric shock.

De-energize PV modules by removing them entirely from light or by covering their front surface with an opaque material. Regard the safety regulations for live electrical equipment when working with modules that are exposed to any light. Use insulated tools and do not wear metallic jewelry while working with PV modules.

In order to avoid arcing and electrical shock, do not disconnect electrical connections under load. Faulty connections can also result in arcing and electrical shock. Keep connectors dry and clean, and ensure that they are in proper working condition. Never insert metallic objects into the connectors, or modify them in any way in order to secure an electrical connection.

Do not touch or handle PV modules with broken glass, separated frames or a damaged backsheet unless the PV modules are first disconnected and you are wearing proper PPE. Avoid handling PV modules when they are wet unless cleaning the PV modules as directed in this manual. Never touch electrical connections that are wet without protecting yourself with insulated gloves.

## Transport and Handling

Yingli Solar PV modules must be transported in the supplied packaging only and kept in the packaging until they are ready to be installed. Protect pallets against movement and exposure to damage during transportation. Secure pallets from falling over. Do not exceed the maximum height of pallets to be stacked, as indicated on the pallet packaging. Store pallets in a cool and dry location until the PV modules are ready to be unpackaged.

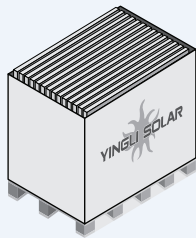

Figure 2: Pallet of PV modules

Yingli Solar PV modules are heavy, and should be handled with care. PV modules shall be handled at the frame; never use the junction box or cables as a grip. Do not exert mechanical stress on the cables. Never step on PV modules or drop or place heavy objects on them. Be careful when placing PV modules on hard surfaces, and secure them from falling. Broken glass can result in personal injury. PV modules with broken glass cannot be repaired and must not be used. Broken or damaged PV modules must be handled carefully and disposed of properly.

For unpacking PV modules from the Yingli Solar supplied packaging, first remove the pallet lid (after removing securing straps, if provided). Remove PV modules one at a time by sliding them up the channel in the package (see Figure 3). You may need to secure the remaining PV modules in the pallet packaging to prevent them from falling over.

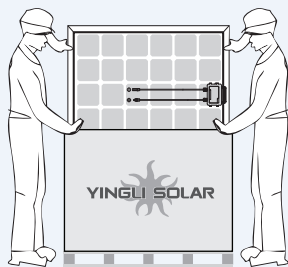

Figure 3: Removing PV modules from a pallet

Check PV modules for damage due to transportation before they are installed; do not install damaged modules. Contact the company you purchased the Yingli

Solar PV modules from in order to obtain information on making claims for defective PV modules.

PV module surfaces are susceptible to damage that could affect the performance or safety of the PV module; do not damage or scratch the PV module surfaces, and do not apply paint or adhesive to any of the surfaces, including the frame. For your safety, do not disassemble or modify Yingli Solar PV modules in any way. Doing so may degrade performance or cause irreparable damage and will void any applicable warranties.

If it is necessary to store PV modules prior to installation, the PV modules should remain inside the packaging and protected from exposure that could compromise the durability of the packaging.

## Fire

Yingli Solar PV Modules have a Class C fire resistance rating in accordance with the IEC 61730-2 certification. When PV modules are mounted on rooftops, the roof must have a fire resistant covering suitable for this application. PV modules are electrical generating devices that may affect the fire safety of a building.

The use of improper installation methods and/or defective parts may result in the unexpected occurrence of an electrical arc during operation. In order to mitigate the risk of fire in this event, PV modules should not be installed near flammable liquids, gases, or locations with hazardous materials.

In the event of a fire, PV modules may continue to produce a dangerous voltage, even if they have been disconnected from the inverter, have been partly or entirely destroyed, or the system wiring has been compromised or destroyed. In the event of fire, inform the fire crew about the particular hazards from the PV system, and stay away from all elements of the PV system during and after a fire until the necessary steps have been taken to make the PV system safe.

## APPLICATION INFORMATION

### Application Restrictions

Yingli Solar PV modules must be mounted on appropriate mounting structures positioned on suitable buildings, the ground, or other structures suitable for PV modules (e.g. carports, building facades or PV trackers). PV modules must not be mounted on moving vehicles of any kind. Yingli Solar PV modules must not be installed in locations where they could be submerged in water.

Yingli Solar PV modules must not be sited in locations where aggressive substances such as salt or salt-water, or any other type of corrosive agent, could affect the safety and/or performance of the PV modules. Although some types of Yingli Solar PV modules have passed the IEC 61701 salt-mist corrosion test with a salt concentration of 5% by weight, galvanic corrosion can occur between the aluminum frame of the PV module and mounting or grounding hardware if such hardware is comprised of dissimilar metals. Yingli Solar recommends that only stainless steel and aluminum metal directly contact PV modules in seaside installations to limit corrosion.

Artificially concentrated light must not be directed on Yingli Solar PV modules.

### Design Recommendations

Yingli Solar recommends that PV modules be mounted at a minimum tilt angle of 10 degrees to allow for proper self-cleaning from normal rain showers.

Partial or complete shading of a PV module or modules can significantly reduce system performance. Yingli Solar recommends minimizing the amount of shade throughout the year to increase the amount of energy produced by the PV modules.

Lightning protection is recommended for PV systems that are to be installed in locations with high probability of lightning strikes.

High system voltages could be induced in the event of an indirect lightning strike, which could cause damage to PV system components. The open area of wire loops should be minimized, as shown in Figure 4, in order to reduce the risk

of lightning induced voltage surges.

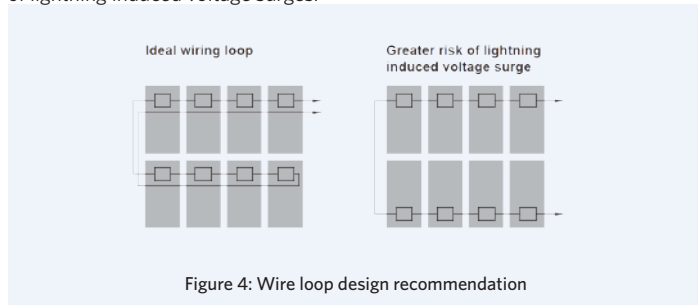

Figure 4: Wire loop design recommendation

## ELECTRICAL INSTALLATION

### Electrical Configuration

Under normal conditions, a photovoltaic module is likely to experience conditions that produce more current and/or voltage than reported at Standard Test Conditions (STC: 1000 W/m<sup>2</sup>, AM 1.5, and 25°C cell temperature). The short-circuit current (ISC) should be multiplied by a factor of 1.25 and the open-circuit voltage (VOC) should be multiplied by a factor of up to 1.25 based on the lowest ambient temperature recorded for the installation location when determining component voltage ratings, conductor current ratings, fuse sizes, and size of controls connected to the PV output.

Voltages are additive when PV modules are connected directly in series, and module currents are additive when PV modules are connected directly in parallel, as illustrated in Figure 5. PV modules with different electrical characteristics must not be connected directly in series. The use of suitable third-party electronic devices connected to PV modules may enable different electrical connections and must be installed according to the manufacturer's specified instructions.

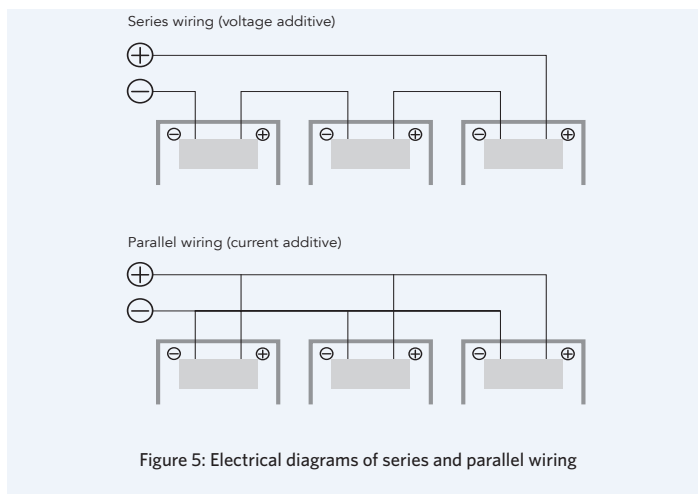

Figure 5: Electrical diagrams of series and parallel wiring

The maximum number of PV modules that can be connected in a series string must be calculated in accordance with applicable regulations in such a way that the specified maximum system voltage of the PV module and all other electrical DC components will not be exceeded in open-circuit operation at the lowest temperature expected at the PV system location.

An appropriately rated overcurrent protection device must be used when the reverse current could exceed the value of the maximum fuse rating of the module. An overcurrent protection device is required for each series string if more than two series strings are connected in parallel.

### Cables and Wiring

Yingli Solar PV modules are provided with two (2) stranded, sunlight resistant output cables that are terminated with PV connectors ready for most installations. The positive (+) terminal has a female connector while the negative (-) terminal has a male connector. The module wiring is intended for

series connections [i.e. female (+) to male (-) interconnections], but can also be used to connect suitable third-party electrical devices that may have alternative wiring configurations so long as the manufacturer's instructions are followed.

Use field wiring with suitable cross-sectional areas that are approved for use at the maximum short-circuit current of the PV module. Yingli Solar recommends installers use only sunlight resistant cables qualified for direct current (DC) wiring in PV systems. The minimum wire size should be 4mm<sup>2</sup>.

Table 1: Required minimum field wiring specifications

	Testing Standard	Wire Size	Temperature Rating
Required Minimum Field Wiring	TÜV 2 PfG 1169	4mm <sup>2</sup>	-40°C to +90°C

Cables should be fixed to the mounting structure in such a way that mechanical damage of the cable and/or the module is avoided. Do not apply stress to the cables. Do not bend cables to a bending radius of less than 40mm. For fixing, use appropriate means, such as sunlight resistant cable ties and/or wire management clips specifically designed to attach to the PV module frame. While the cables are sunlight resistant and waterproof, where possible, avoid direct sunlight exposure and water immersion of the cables.

### Connectors



Keep connectors dry and clean, and ensure that connector caps are hand tight before connecting the modules. Do not attempt making an electrical connection with wet, soiled, or otherwise faulty connectors. Avoid sunlight exposure and water immersion of the connectors. Avoid connectors resting

on the ground or roof surface.

Faulty connections can result in arcs and electrical shock. Check that all electrical connections are securely fastened. Make sure that all locking connectors are fully engaged and locked.

Modules must not be interconnected using connectors from different manufacturers and / or of different types. If modules having such different connectors need to be interconnected, a qualified professional may replace connectors according to the manufacturers' specified instructions such that an interconnection can be made with connectors from the same manufacturer and the same type.

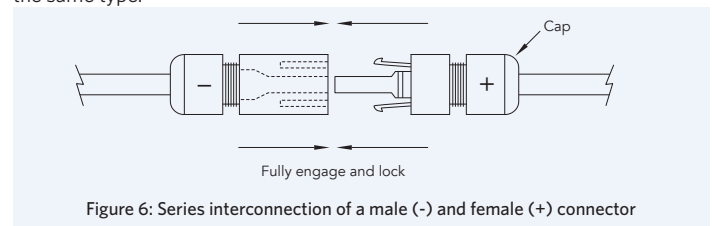

Figure 6: Series interconnection of a male (-) and female (+) connector

### Bypass Diodes

The junction boxes used with Yingli Solar PV modules (not Smart Hot Spot Free module) contain bypass diodes wired in parallel with the PV cell strings. In the case of partial shading, the diodes bypass the current generated by the non-shaded cells, thereby limiting module heating and performance losses. Bypass diodes are not overcurrent protection devices.

Bypass diodes divert current from the cell strings in the event of partial shading. See Figure 7-1 for a diagram showing how the cell strings are electrically connected with the diodes.

Every piece of cells from Yingli Smart Hot Spot Free module parallels a diode, with a cell is covered by shade or occurs an exception, the paralleled diode can bypass this cell, thus avoid hot spot, and can retain the maximum power output.

Bypass diodes divert current from a cell in the event of partial shading, See figure 7-2 for a diagram showing how the cells are electrically connected with the diodes.

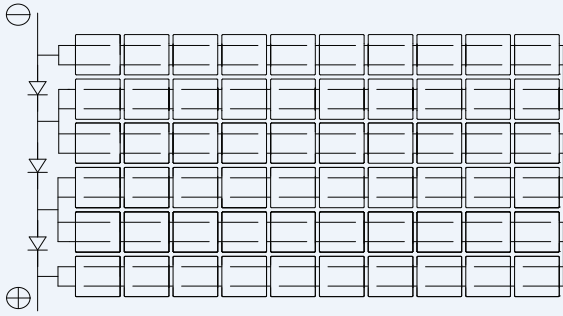

Figure 7-1: Electrical circuitry of cells and bypass diodes

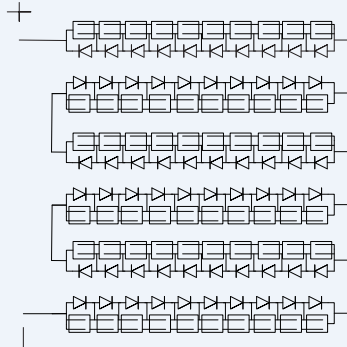

Figure 7-2: Electrical circuitry of cells and bypass diodes

In the event of a known or suspected diode failure, installers or maintenance providers should contact the company the PV modules were purchased from. Never attempt to open the junction box of a Yingli Solar PV module yourself.

### PV Array Grounding

For optimal performance, Yingli Solar recommends that the negative pole of the PV array be connected to ground.

### Equipment Grounding

The frame of the PV module, as well as any exposed non-current-carrying metal parts of fixed equipment that are able to become energized by the PV system, must be connected to the equipment grounding conductor (EGC) in order to prevent electrical shock. Even when applicable regulations, code requirements, and standards do not require safety-related grounding, Yingli Solar recommends grounding all PV module frames in order to ensure the voltage between electrically conductive equipment and earth ground is zero in all circumstances.

Proper equipment grounding is achieved by bonding all exposed non-current-carrying metal equipment continuously to one another using an appropriately sized EGC or racking system that can be used for integrated grounding (see Option B in Grounding Methods below).

Yingli Solar PV modules employ a coated aluminum frame for corrosion resistance. In order to properly ground the module frame, the coating must be penetrated.

The potential for corrosion due to the electrochemical action between dissimilar metals in contact is minimized if the electrochemical voltage potential between the dissimilar metals is low. The grounding method must not result in the direct contact of dissimilar metals with the aluminum frame of the PV module that will result in galvanic corrosion. An addendum to UL Standard 1703 "Flat Plate Photovoltaic Modules and Panels" recommends metal combinations not exceed an electrochemical potential difference of 0.5 Volts.

The frame rails have pre-drilled holes marked with a grounding sign, as illustrated in Figure 8. These holes should be used for grounding purposes and must not be used for mounting the PV modules. Do not drill additional holes into the frame rails.

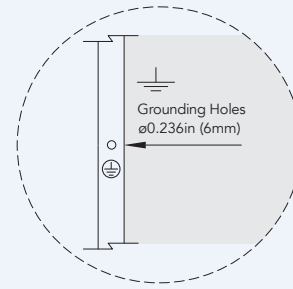

Figure 8: Grounding hole detail

The following grounding methods are available:

### Option A: Screw Assembly (see Figure 9)

1. A grounding screw assembly must be attached at a designated grounding hole location using only stainless steel hardware. Insert an M5 stainless steel screw first through the stainless steel cup washer, and then through the grounding hole.
2. Loosely engage a stainless steel backing nut and toothed lock washer to the screw.
3. Bend the EGC into an omega ( $\Omega$ ) shape to tightly fit between the partially installed screw head and cup washer. The EGC shall be exclusively in contact with stainless steel.
4. Tighten the screw to 2.3 N-m torque. The toothed lock washer should be visibly engaged to the frame.
5. Route the appropriately sized EGC in such a way as to avoid contact with the aluminum module frame.

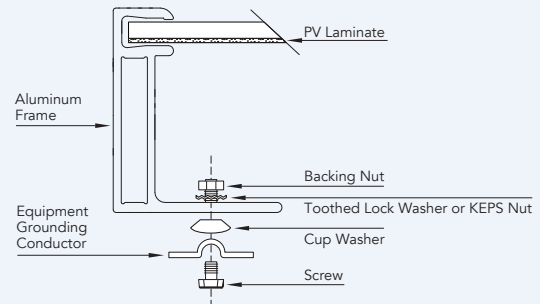

Figure 9: Grounding screw assembly detail

### Option B: Racking Manufacturer Integrated Grounding Methods

Yingli Solar PV modules can be grounded by bonding PV modules to a grounded racking system. Integrated grounding methods must be certified for grounding PV modules and must be installed in accordance with the specified instructions of their respective manufacturers.

### Option C: Additional Third-party Grounding Devices

Yingli Solar PV modules can be grounded using third party grounding devices so long as they are certified for grounding PV modules and the devices are installed according to the manufacturer's specified instructions.

## MECHANICAL INSTALLATION

### General

Yingli Solar PV Modules have been certified for a maximum static load on the back of the module of up to 2400 Pa (i.e. wind load) and a maximum static load on the front of the module of up to either 2400 Pa or 5400 Pa (i.e. wind and snow load), depending on the module type (please refer to the data sheet for

this information).

Mounting structures and other mechanical parts must be designed and approved to withstand the design wind and snow loads applicable for a particular site. Yingli Solar PV modules must not be subjected to forces from the substructure, including forces caused by thermal expansion.

The mounting method must not result in the direct contact of dissimilar metals with the aluminum frame of the PV module that will result in galvanic corrosion. An addendum to UL Standard 1703 "Flat Plate Photovoltaic Modules and Panels" recommends metal combinations not exceed an electrochemical potential difference of 0.5 Volts.

Yingli Solar PV modules can be mounted in landscape or portrait orientation, as illustrated in Figure 10, provided that the mounting method follows one of the acceptable methods listed below.

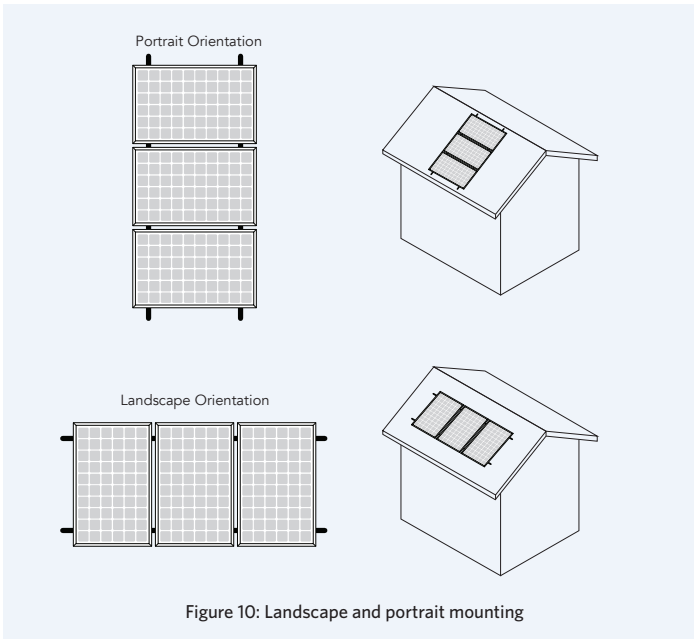

Figure 10: Landscape and portrait mounting

In order to maintain the fire class rating, the distance between the PV module front surface (glass) and the roof surface shall be at least 10 cm. This spacing also allows air flow to cool the PV module. Install PV modules with a minimum spacing of 1 cm between neighboring frames to allow for thermal expansion.

### Mounting Methods

The following mounting methods are available:

#### Bolts or Clamps

Refer to the Module Supplement distributed with this manual to determine how many connection points are required for a specific module series. The locations of mounting holes and clamp tolerances are illustrated in the drawings located in the Module Supplement. Do not modify the existing mounting holes or drill new holes. Do not apply excessive pressure on the frame such that the frame deforms.

- **Bolts:** Modules must be mounted using the mounting holes located on the rear side of the long frame parts using M6 stainless steel bolts, nuts, and washers. Refer to the racking manufacturer for specific torque requirements.

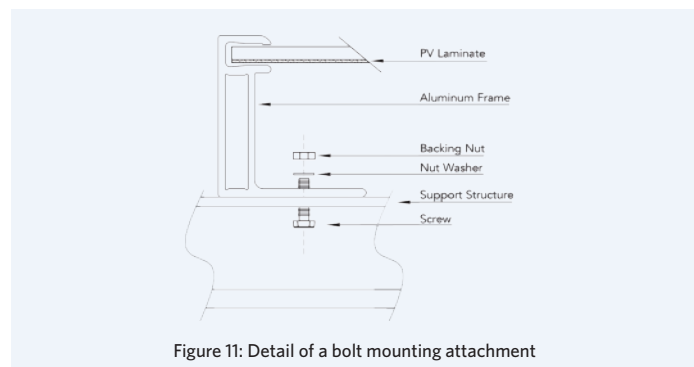

Figure 11: Detail of a bolt mounting attachment

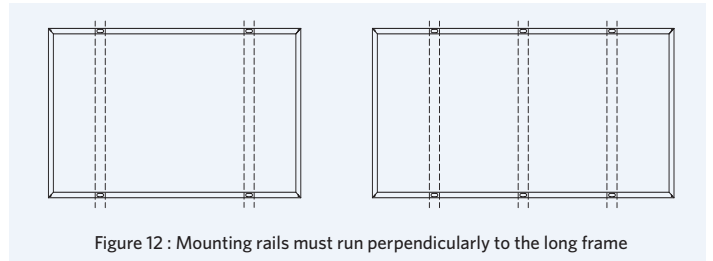

Figure 12 : Mounting rails must run perpendicularly to the long frame

- **Top-down Clamps:** Third-party clamps that have been designed for PV mounting structures are an approved mounting attachment method for Yingli Solar PV modules. Modules must be fastened using clamps applied to the top side of the long frame parts. A clamp holds two modules except for the clamps at the beginning and end of a module row. The centerline of the clamps must be in line with the mounting hole positions plus or minus a distance of 50mm. Clamps must be installed according to the manufacturer's specified instructions.

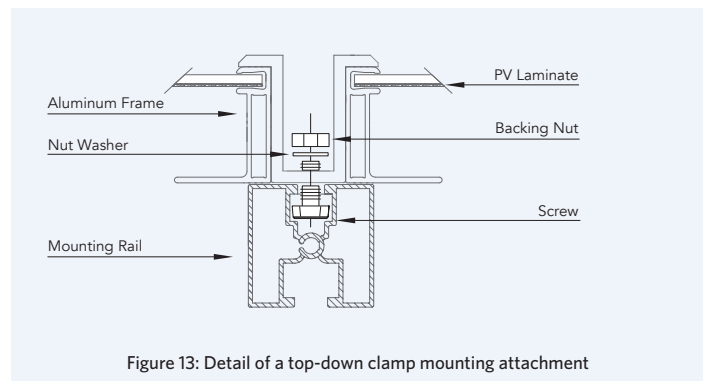

Figure 13: Detail of a top-down clamp mounting attachment

## MAINTENANCE

### General

Yingli Solar recommends that PV systems be periodically inspected by the installer, or other qualified person.

The purpose of the PV system inspection is to ensure that all system components are functioning properly. At a minimum, this inspection should confirm the following:

- All cables and connector attachments are undamaged and properly secured
- No sharp objects are in contact with the PV module surfaces
- PV modules are not shaded by unwanted obstacles and/or foreign material
- Mounting and grounding components are tightly secured with no corrosion

Defects should be addressed immediately.

### Cleaning

Over time, dirt and dust can accumulate on the glass surface of the module, reducing its power output. Yingli Solar recommends periodic cleaning of PV modules to ensure maximum power output, especially in regions with low precipitation.

In order to reduce the potential for electrical and thermal shock, Yingli Solar recommends cleaning PV modules during early morning or late afternoon hours when solar radiation is low and the modules are cooler, especially in regions with hotter temperatures.

Never attempt to clean a PV module with broken glass or other signs of exposed wiring, as this presents a shock hazard.

Clean the glass surface of the PV modules with a soft brush using soft, clean water with a recommended pressure less than 690kPa, which is typical of most

municipal water systems. Water with high mineral content may leave deposits on the glass surface and is not recommended.

Yingli Solar PV modules may contain a hydrophobic anti-reflective coating on the glass surface to enhance power output and reduce dirt and dust buildup. In order to avoid module damage, do not clean PV modules with a power washer or pressure washer. Do not use steam or corrosive chemicals to facilitate the cleaning of modules. Do not use aggressive tools or abrasive materials that could scratch or damage the glass surface. Failure to comply with these requirements may adversely affect the PV module performance.

Yingli Solar PV modules are designed to withstand high snow loads. However, if removing snow is desired to enhance production, use a brush to gently remove snow. Do not try to remove frozen snow or ice from PV modules.

## **DECOMMISSIONING**

The dismantling of PV systems must be performed with the same care and safety precautions used during the initial installation. The PV system can generate hazardous voltage even after the system has been disconnected. Follow safety regulations for working with live electrical equipment.

## **RECYCLING**

Yingli Solar is a member of PV Cycle, the European association for voluntary take back and recycling of PV modules. Please contact PV Cycle at [www.pvcycle.org](http://www.pvcycle.org) for details regarding the recycling process.

### **Yingli Green Energy Holding Co., Ltd.**

[service@yingli.com](mailto:service@yingli.com)

Service hotline:+86-312-2188055

Complaints hotline:+86-312-8922216

**YINGLISOLAR.COM** | **NYSE:YGE**



# YINGLI SOLAR PV MODULES

## Module Supplement



Revision Date Jul 27th, 2017 | Applicable for IEC certified products.

The information in this supplement is believed to be reliable, but does not constitute an expressed or implied warranty. Yingli Solar reserves the right to make changes to its PV modules and other products, their specifications, or this supplement without prior notice.

This supplement to the installation manual does not contain information about some older module series no longer being manufactured by Yingli Solar. If you require information about such modules, please contact Yingli Solar.

This supplement refers to modules of the following types:

**Table 1: Module types**

FAMILY	YGE 60 Cell Series 2	YGE 72 Cell Series 2	YGE 60 Cell Series 2 HSF Smart	YGE 72 Cell Series 2 HSF Smart	YGE 60 Cell Series 2 Black Silicon	YGE 72 Cell Series 2 Black Silicon	PANDA 60 Cell Series 2	PANDA 72 Cell Series 2
TYPE	YL250P-29b	YL300P-35b	YL250PD-29b	YL310PD-35b	YL250P-29b	YL300P-35b	YL260C-30b	YL310C-36b
	YL255P-29b	YL305P-35b	YL255PD-29b	YL315PD-35b	YL255P-29b	YL305P-35b	YL265C-30b	YL315C-36b
	YL260P-29b	YL310P-35b	YL260PD-29b	YL320PD-35b	YL260P-29b	YL310P-35b	YL270C-30b	YL320C-36b
	YL265P-29b	YL315P-35b	YL265PD-29b	YL325PD-35b	YL265P-29b	YL315P-35b	YL275C-30b	YL325C-36b
	YL270P-29b	YL320P-35b	YL270PD-29b	YL330PD-35b	YL270P-29b	YL320P-35b	YL280C-30b	YL330C-36b
	YL275P-29b	YL325P-35b	YL275PD-29b	YL335PD-35b	YL275P-29b	YL325P-35b	YL285C-30b	YL335C-36b
	YL280P-29b	YL330P-35b	YL280PD-29b	YL340PD-35b	YL280P-29b	YL330P-35b	YL290C-30b	YL340C-36b
	YL285P-29b	YL335P-35b	YL285PD-29b	YL345PD-35b	YL285P-29b	YL335P-35b	YL295C-30b	YL345C-36b
	YL290P-29b	YL340P-35b	YL290PD-29b	YL350PD-35b	YL290P-29b	YL340P-35b	YL300C-30b	YL350C-36b
		YL345P-35b				YL345P-35b		YL355C-36b
		YL350P-35b				YL350P-35b		YL360C-36b

FAMILY	YLM 60 Cell HSF Smart	YLM 72 Cell HSF Smart	YLM 60 Cell	YLM 72 Cell
TYPE	YL270DD-30b	YL330DD-36b	YL260D-30b	YL315D-36b
	YL275DD-30b	YL335DD-36b	YL265D-30b	YL320D-36b
	YL280DD-30b	YL340DD-36b	YL270D-30b	YL325D-36b
	YL285DD-30b	YL345DD-36b	YL275D-30b	YL330D-36b
	YL290DD-30b	YL350DD-36b	YL280D-30b	YL335D-36b
	YL295DD-30b	YL355DD-36b	YL285D-30b	YL340D-36b
	YL300DD-30b	YL360DD-36b	YL290D-30b	YL345D-36b
	YL305DD-30b	YL365DD-36b		YL350D-36b
	YL310DD-30b	YL370DD-36b		
	YL315DD-30b	YL375DD-36b		
	YL320DD-30b	YL380DD-36b		
	YL325DD-30b	YL385DD-36b		
		YL390DD-36b		

## MOUNTING REQUIREMENTS

### Mounting Method: Bolts and Clamps

Table 2: Mounting requirements

Modules that Require Four (4) Connection Points	Modules that Require Six (6) Connection Points
YGE 60 Cell Series 2	YGE 72 Cell Series 2
YLM 60 Cell	YLM 72 Cell
PANDA 60 Cell Series 2	PANDA 72 Cell Series 2
YGE 60 Cell Series 2 HSF Smart	YGE 72 Cell Series 2 HSF Smart
YLM 60 Cell HSF Smart	YLM 72 Cell HSF Smart
YGE 60 Cell Series 2 Black Silicon	YGE 72 Series 2 Cell Black Silicon

## ELECTRICAL CHARACTERISTICS

Nameplate ratings are average values. The electrical characteristics are within +/- 10 percent of the indicated values of  $I_{sc}$ ,  $V_{oc}$ , and  $P_{max}$  under Standard Test Conditions (irradiance of  $1000 \text{ W/m}^2$ , AM 1.5 spectrum, and a cell temperature of  $25^\circ\text{C}$ ). Refer to module datasheets for specific power output tolerances. Note that not necessarily all power classes are available for all module series given in the first column of Table 3. Please refer to Table 1 to see which power classes actually exist for which module series.

Table 3: Electrical characteristics

Series	Module	$P_{max}$	$V_{mpp}$	$I_{mpp}$	$V_{oc}$	$I_{sc}$	Max. system voltage	Max. series fuse rating
		[W]	[V]	[A]	[V]	[A]	[V]	[A]
YGE 60 Cell Series 2	YL290P-29b	290	31.8	9.12	38.5	9.65	1000	15
	YL285P-29b	285	31.6	9.02	38.4	9.55	1000	15
	YL280P-29b	280	31.4	8.92	38.2	9.45	1000	15
	YL275P-29b	275	31.0	8.90	37.9	9.35	1000	15
	YL270P-29b	270	30.7	8.80	37.9	9.27	1000	15
	YL265P-29b	265	30.5	8.70	37.8	9.18	1000	15
	YL260P-29b	260	30.3	8.59	37.7	9.09	1000	15
	YL255P-29b	255	30.0	8.49	37.7	9.01	1000	15
	YL250P-29b	250	29.8	8.39	37.6	8.92	1000	15
YGE 72 Cell Series 2	YL350P-35b	350	38.2	9.17	47.6	9.50	1000	15
	YL345P-35b	345	38.0	9.08	47.3	9.45	1000	15
	YL340P-35b	340	37.8	9.00	47.0	9.40	1000	15
	YL335P-35b	335	37.6	8.91	46.7	9.34	1000	15
	YL330P-35b	330	37.4	8.84	46.4	9.29	1000	15
	YL325P-35b	325	37.3	8.72	46.3	9.24	1000	15
	YL320P-35b	320	37.0	8.64	46.0	9.18	1000	15
	YL315P-35b	315	36.8	8.56	45.7	9.12	1000	15
	YL310P-35b	310	36.3	8.53	45.6	8.99	1000	15
	YL305P-35b	305	36.1	8.45	45.4	8.93	1000	15
YL300P-35b	300	35.8	8.37	45.2	8.86	1000	15	



<b>PANDA 60 Cell Series 2</b>	YL300C-30b	300	32.7	9.16	40.1	9.66	1000	15
	YL295C-30b	295	32.4	9.11	39.9	9.62	1000	15
	YL290C-30b	290	32.0	9.06	39.6	9.58	1000	15
	YL285C-30b	285	31.6	9.01	39.4	9.54	1000	15
	YL280C-30b	280	31.3	8.96	39.1	9.50	1000	15
	YL275C-30b	275	30.9	8.91	38.8	9.47	1000	15
	YL270C-30b	270	30.5	8.85	38.6	9.43	1000	15
	YL265C-30b	265	30.1	8.79	38.3	9.37	1000	15
<b>PANDA 72 Cell Series 2</b>	YL360C-36b	360	40.2	8.95	47.8	9.27	1000	15
	YL355C-36b	355	39.8	8.92	47.6	9.26	1000	15
	YL350C-36b	350	39.4	8.89	47.4	9.26	1000	15
	YL345C-36b	345	39.0	8.85	47.2	9.26	1000	15
	YL340C-36b	340	38.5	8.82	47.0	9.25	1000	15
	YL335C-36b	335	38.1	8.79	46.8	9.25	1000	15
	YL330C-36b	330	37.7	8.76	46.6	9.25	1000	15
	YL325C-36b	325	37.3	8.72	46.4	9.24	1000	15
	YL320C-36b	320	36.8	8.69	46.2	9.24	1000	15
YL315C-36b	315	36.4	8.65	46.0	9.23	1000	15	
<b>YGE 60 Cell Series 2 HSF Smart</b>	YL290PD-29b	290	31.8	9.12	38.5	9.65	1000	15
	YL285PD-29b	285	31.6	9.02	38.4	9.55	1000	15
	YL280PD-29b	280	31.4	8.92	38.2	9.45	1000	15
	YL275PD-29b	275	31.0	8.90	37.9	9.35	1000	15
	YL270PD-29b	270	30.7	8.80	37.9	9.27	1000	15
	YL265PD-29b	265	30.5	8.70	37.8	9.18	1000	15
	YL260PD-29b	260	30.3	8.59	37.7	9.09	1000	15
	YL255PD-29b	255	30.0	8.49	37.7	9.01	1000	15
YL250PD-29b	250	29.8	8.39	37.6	8.92	1000	15	
<b>YGE 72 Cell Series 2 HSF Smart</b>	YL350PD-35b	350	38.2	9.17	47.6	9.50	1000	15
	YL345PD-35b	345	38.0	9.08	47.3	9.45	1000	15
	YL340PD-35b	340	37.8	9.00	47	9.40	1000	15
	YL335PD-35b	335	37.6	8.91	46.7	9.34	1000	15
	YL330PD-35b	330	37.4	8.84	46.4	9.29	1000	15
	YL325PD-35b	325	37.3	8.72	46.3	9.24	1000	15
	YL320PD-35b	320	37.0	8.64	46	9.18	1000	15
	YL315PD-35b	315	36.8	8.56	45.7	9.12	1000	15
YL310PD-35b	310	36.3	8.53	45.6	8.99	1000	15	
<b>YGE 60Cell Series 2 Black Silicon</b>	YL290P-29b	290	31.8	9.12	38.5	9.65	1000	15
	YL285P-29b	285	31.6	9.02	38.4	9.55	1000	15
	YL280P-29b	280	31.4	8.92	38.2	9.45	1000	15
	YL275P-29b	275	31.0	8.90	37.9	9.35	1000	15
	YL270P-29b	270	30.7	8.80	37.9	9.27	1000	15
	YL265P-29b	265	30.5	8.70	37.8	9.18	1000	15
	YL260P-29b	260	30.3	8.59	37.7	9.09	1000	15
	YL255P-29b	255	30.0	8.49	37.7	9.01	1000	15
YL250P-29b	250	29.8	8.39	37.6	8.92	1000	15	

<b>YGE 72 Cell Series 2 Black Silicon</b>	YL350P-35b	350	38.2	9.17	47.6	9.50	1000	15
	YL345P-35b	345	38.0	9.08	47.3	9.45	1000	15
	YL340P-35b	340	37.8	9.00	47.0	9.40	1000	15
	YL335P-35b	335	37.6	8.91	46.7	9.34	1000	15
	YL330P-35b	330	37.4	8.84	46.4	9.29	1000	15
	YL325P-35b	325	37.3	8.72	46.3	9.24	1000	15
	YL320P-35b	320	37.0	8.64	46.0	9.18	1000	15
	YL315P-35b	315	36.8	8.56	45.7	9.12	1000	15
	YL310P-35b	310	36.3	8.53	45.6	8.99	1000	15
	YL305P-35b	305	36.1	8.45	45.4	8.93	1000	15
	YL300P-35b	300	35.8	8.37	45.2	8.86	1000	15
<b>YLM 60 Cell</b>	YL290D-30b	290	31.9	9.08	39.9	9.45	1000	15
	YL285D-30b	285	31.7	9.00	39.6	9.41	1000	15
	YL280D-30b	280	31.4	8.91	39.3	9.38	1000	15
	YL275D-30b	275	31.2	8.82	38.9	9.34	1000	15
	YL270D-30b	270	30.9	8.73	38.6	9.31	1000	15
	YL265D-30b	265	30.7	8.64	38.3	9.27	1000	15
	YL260D-30b	260	30.4	8.56	38.0	9.24	1000	15
<b>YLM 72 Cell</b>	YL350D-36b	350	38.6	9.07	48.0	9.41	1000	15
	YL345D-36b	345	38.3	9.02	47.7	9.38	1000	15
	YL340D-36b	340	37.9	8.97	47.3	9.35	1000	15
	YL335D-36b	335	37.6	8.91	46.9	9.32	1000	15
	YL330D-36b	330	37.2	8.86	46.6	9.29	1000	15
	YL325D-36b	325	36.9	8.81	46.2	9.27	1000	15
	YL320D-36b	320	36.6	8.75	45.9	9.24	1000	15
	YL315D-36b	315	36.2	8.69	45.5	9.21	1000	15
<b>YLM 60 Cell HSF Smart</b>	YL325DD-30b	325	33.8	9.62	42.3	9.92	1000	15
	YL320DD-30b	320	33.5	9.55	41.7	9.85	1000	15
	YL315DD-30b	315	33.2	9.49	41.3	9.79	1000	15
	YL310DD-30b	310	32.9	9.42	41.2	9.68	1000	15
	YL305DD-30b	305	32.7	9.33	40.9	9.58	1000	15
	YL300DD-30b	300	32.4	9.23	40.5	9.51	1000	15
	YL295DD-30b	295	32.2	9.16	40.0	9.48	1000	15
	YL290DD-30b	290	31.9	9.08	39.9	9.45	1000	15
	YL285DD-30b	285	31.7	9	39.6	9.42	1000	15
	YL280DD-30b	280	31.4	8.91	39.3	9.38	1000	15
	YL275DD-30b	275	31.2	8.82	38.9	9.34	1000	15
	YL270DD-30b	270	30.9	8.73	38.6	9.31	1000	15
<b>YLM 72 Cell HSF Smart</b>	YL390DD-36b	390	41.0	9.52	50.8	9.9	1000	15
	YL385DD-36b	385	40.7	9.46	50.5	9.82	1000	15
	YL380DD-36b	380	40.4	9.41	50.2	9.76	1000	15
	YL375DD-36b	375	40.1	9.35	49.8	9.7	1000	15
	YL370DD-36b	370	39.9	9.28	49.5	9.68	1000	15
	YL365DD-36b	365	39.5	9.25	49.1	9.63	1000	15
	YL360DD-36b	360	39.2	9.19	48.7	9.61	1000	15
	YL355DD-36b	355	38.8	9.15	48.3	9.44	1000	15
	YL350DD-36b	350	38.63	9.06	48.0	9.41	1000	15
	YL345DD-36b	345	38.3	9.02	47.7	9.38	1000	15
	YL340DD-36b	340	37.9	8.97	47.3	9.35	1000	15
	YL335DD-36b	335	37.6	8.91	46.9	9.32	1000	15
	YL330DD-36b	330	37.2	8.86	46.6	9.29	1000	15

## REAR AND SIDE VIEW DIMENSIONS OF MODULE SERIES WITH 40MM FRAME (CONT.)

UNITS: mm

### YGE 72 Cell Series 2

(also valid for YLM 72 Cell, YGE 72 Cell Series 2 Black Silicon, PANDA 72 Cell Series 2)

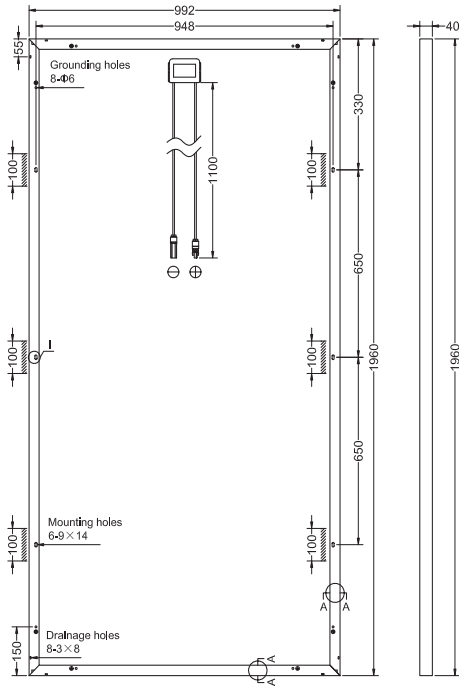

### Frame Cross Section

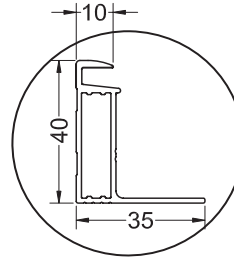

SECTION A-A

### Legend

- Grounding holes
- ⊗ Mounting holes
- Drainage holes
- ▨ Mounting tolerance

### YGE 72 Cell Series 2 HSF Smart

(also valid for YLM 72 Cell HSF Smart)

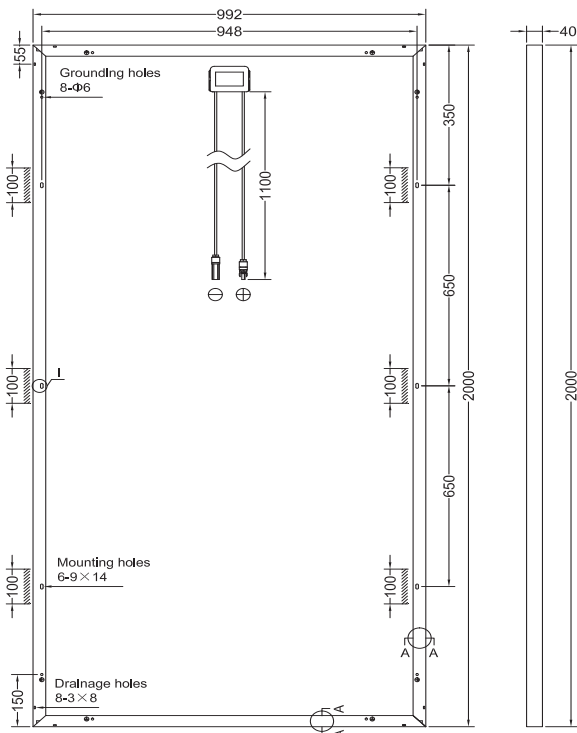

## REAR AND SIDE VIEW DIMENSIONS OF MODULE SERIES WITH 35MM FRAME

UNITS: mm

### YGE 60 Cell Series 2 (also valid for PANDA 60 Cell Series2, YGE 60 Cell Series 2 Black Silicon and YLM 60 Cell)

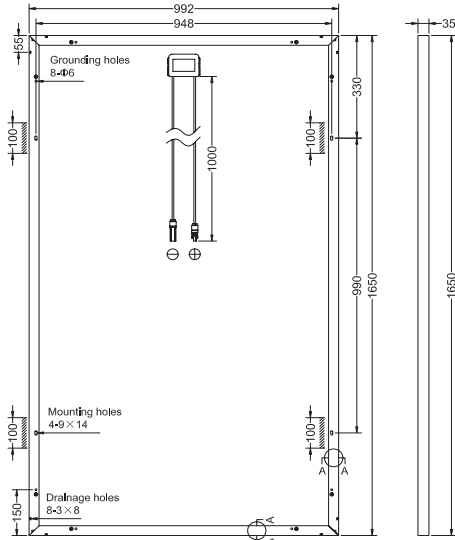

### Frame Cross Section

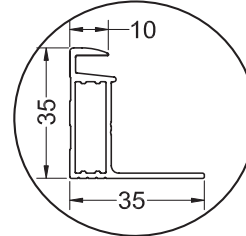

SECTION A-A

### Legend

- Grounding holes
- Mounting holes
- Drainage holes
- ▨ Mounting tolerance

### YGE 60 Cell Series 2 HSF Smart (also valid for YLM 60 Cell HSF Smart)

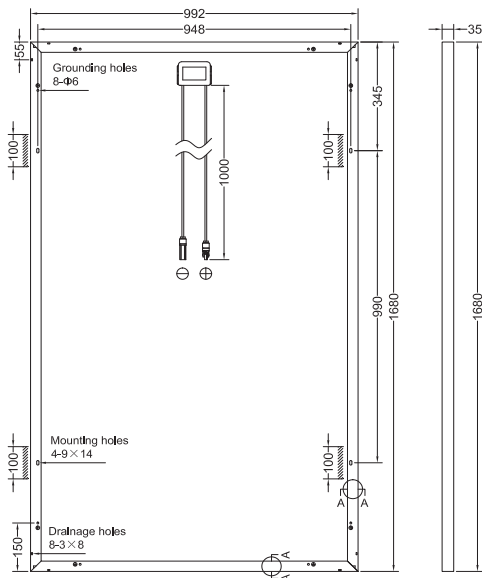

**Yingli Green Energy Holding Co., Ltd.**

service@yingli.com

Service hotline:+86-312-2188055

Complaints hotline:+86-312-8922216

**YINGLISOLAR.COM** | **NYSE:YGE**